

BLACK TIE



Home Decor

MODULARITY PROPOSAL
PROPOSTE MODULARITÀ

LEVANTE

Pier Luigi Frighetto, 2016



SUGGESTED COMPOSITIONS

COMPOSIZIONI SUGGERITE

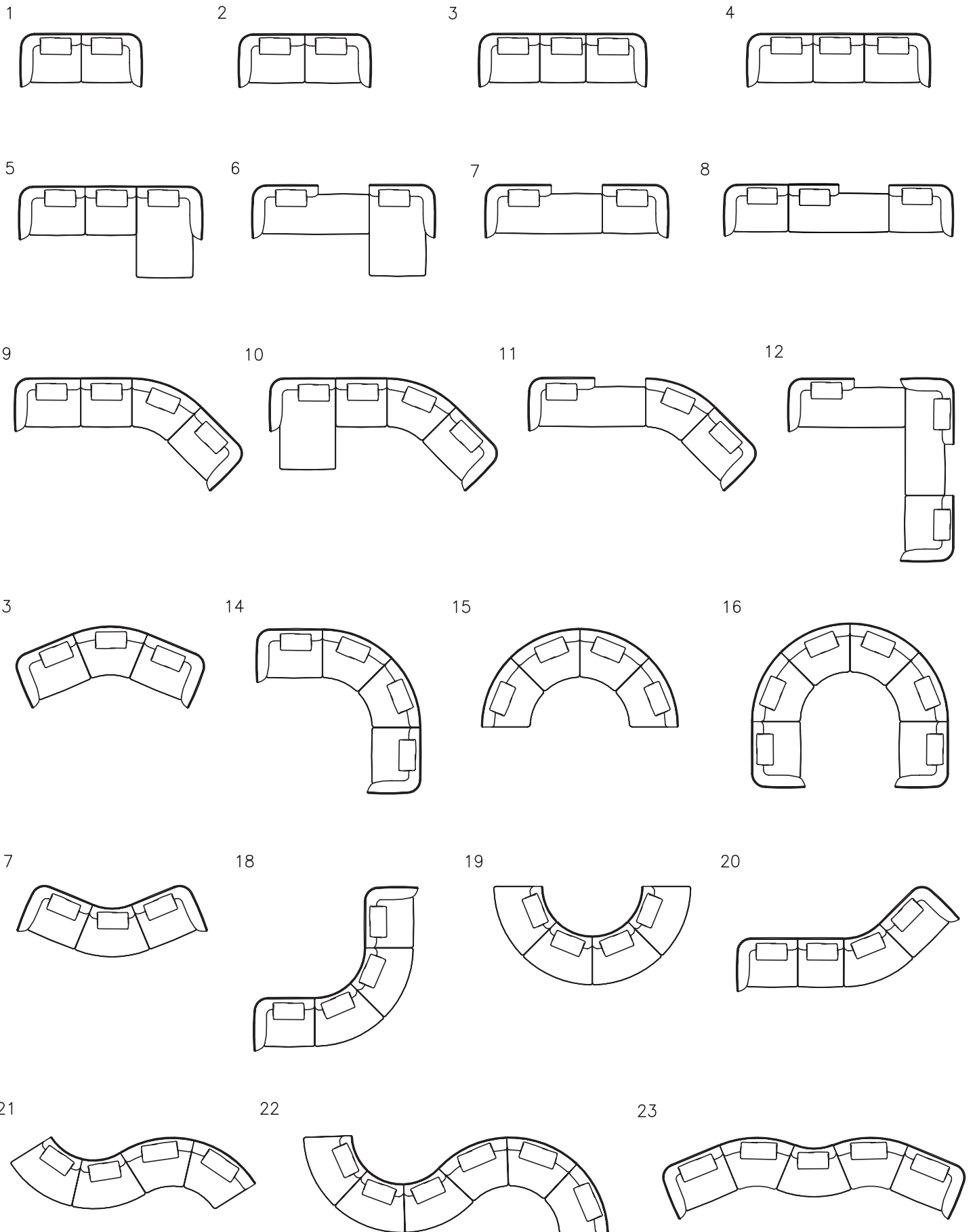

ELEMENTS

ELEMENTI

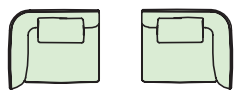

TERMINAL ELEMENT 120
ELEMENTO TERMINALE 120

DX-LEV3E
SX-LEV3F

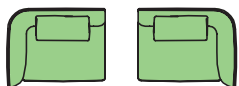

TERMINAL ELEMENT 130
ELEMENTO TERMINALE 130

DX-LEV5G
SX-LEV5H



LINEAR ELEMENT 90
ELEMENTO LINEARE 90

LEV20



LINEAR ELEMENT 100
ELEMENTO LINEARE 100

LEV30

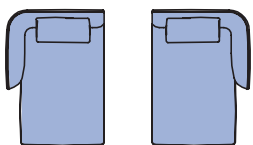

DORMEUSE 180
DORMEUSE 180

DX-LEV1A
SX-LEV1B

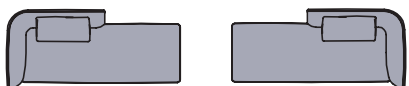

OPEN TERMINAL 230
TERMINALE APERTO 230

DX-LEV7N
SX-LEV7P



OPEN ELEMENT 200
ELEMENTO APERTO 200

DX-LEV6L
SX-LEV6M

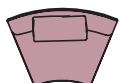

CURVE ELEMENT
ELEMENTO CURVO

LEVCURV



CONVEX ELEMENT
ELEMENTO CONVESSO

LEVCONV

OPTION 1 1 x SX-LEV3F
1 x DX-LEV3E

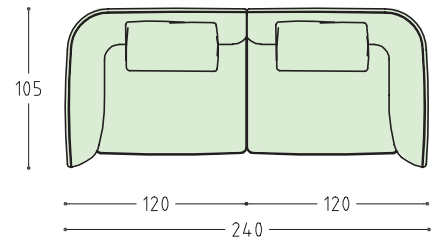

OPTION 2 1 x SX-LEV5H
1 x DX-LEV5G

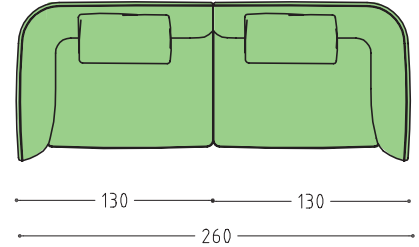

OPTION 3 1 x SX-LEV3F
1 x LEV20
1 x DX-LEV3E

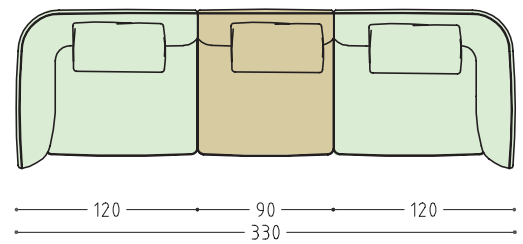

OPTION 4 1 x SX-LEV5H
1 x LEV30
1 x DX-LEV5G

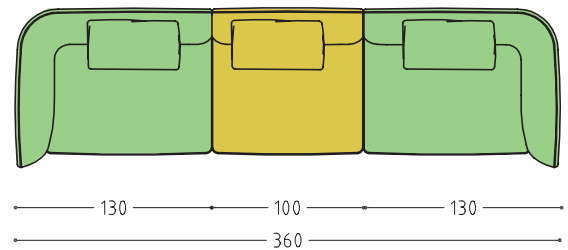

OPTION 5 1 x SX-LEV5H
1 x LEV30
1 x DX-LEV1A

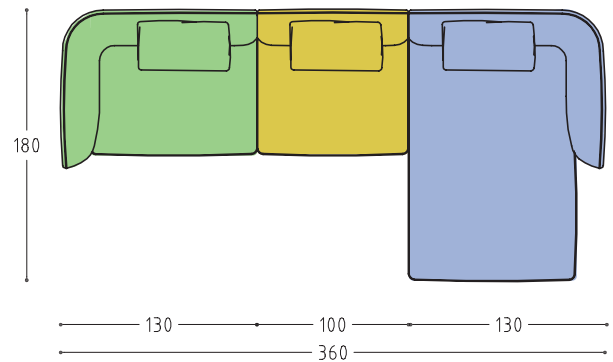

OPTION 6 1 x SX-LEV7P
1 x DX-LEV1A

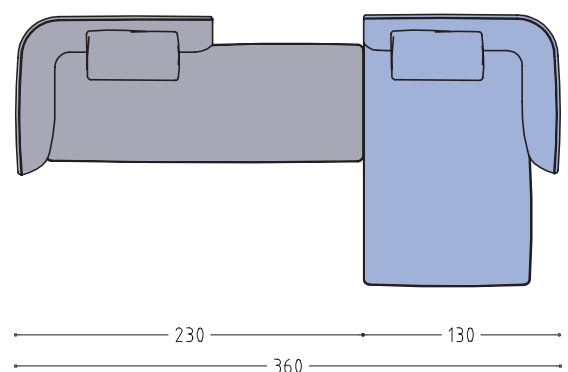

OPTION 7

1 x SX-LEV7P
1 x DX-LEV5G

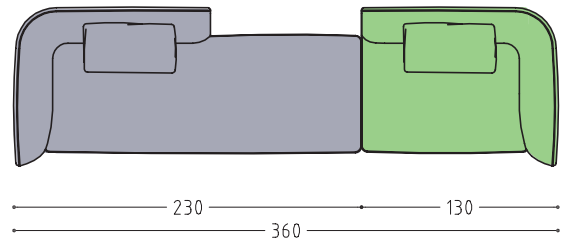

OPTION 8

1 x SX-LEV5H
1 x SX-LEV6M
1 x DX-LEV5G

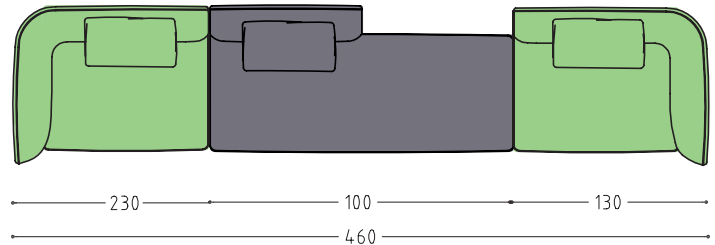

OPTION 9

1 x SX-LEV5H
1 x LEV30
1 x LEVCURV
1 x DX-LEV5G

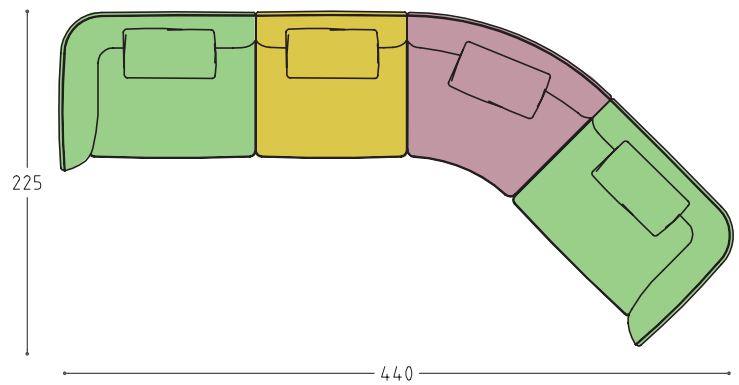

OPTION 10

1 x SX-LEV1B
1 x LEV30
1 x LEVCURV
1 x DX-LEV5G

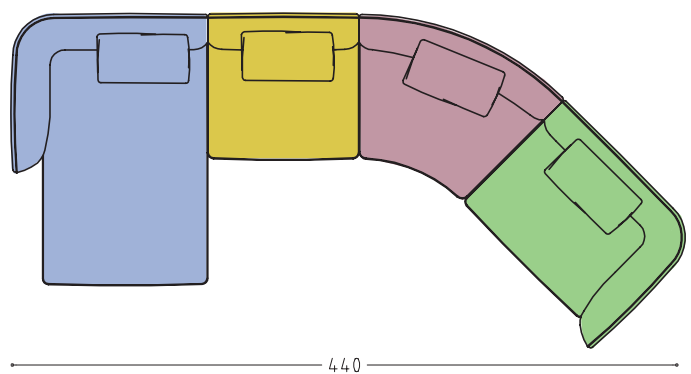

OPTION 11

1 x SX-LEV7P
1 x LEVCURV
1 x DX-LEV5G

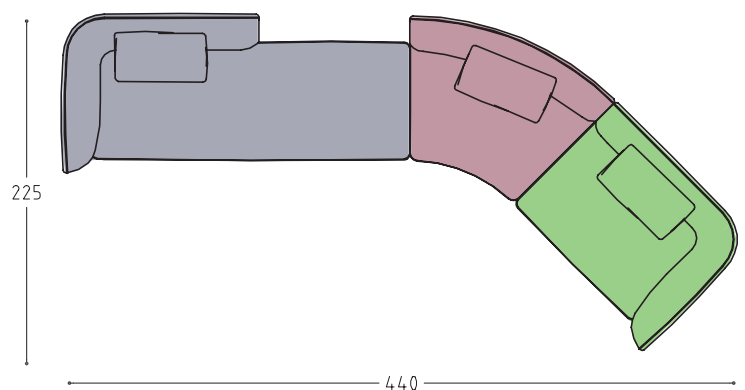

OPTION 12 2 x SX-LEV7P
1 x DX-LEV5G

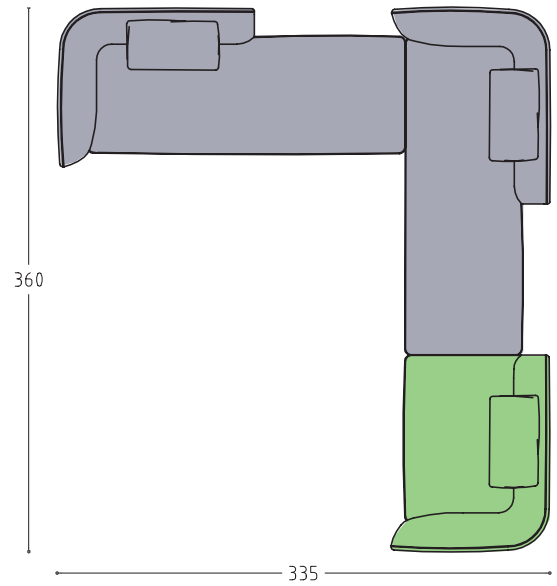

OPTION 13 1 x SX-LEV5H
1 x LEVCURV
1 x DX-LEV5G

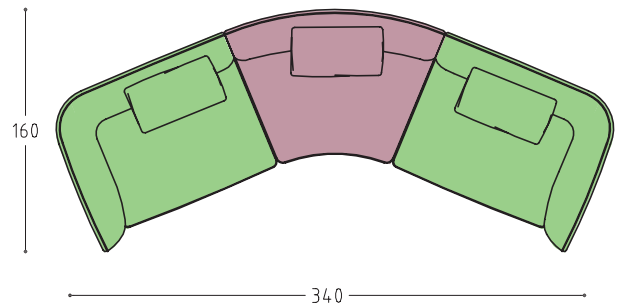

OPTION 14 1 x SX-LEV5H
2 x LEVCURV
1 x DX-LEV5G

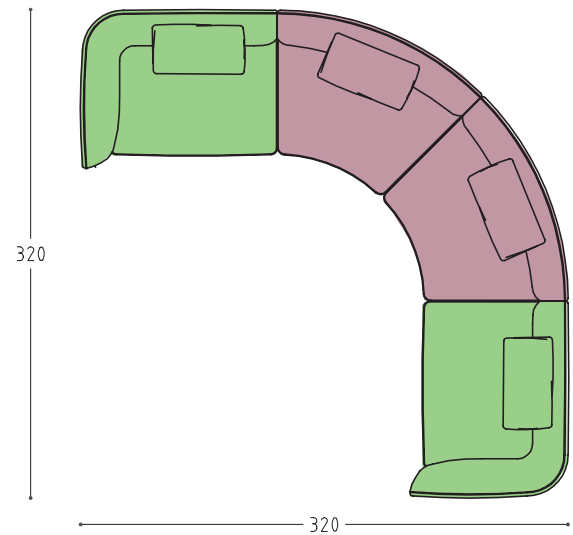

OPTION 15 4 x LEVCURV

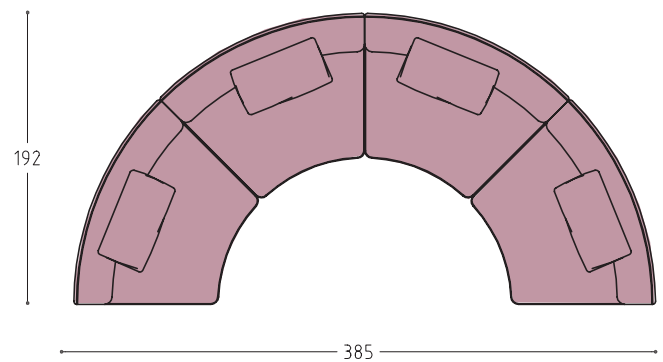

OPTION 16 1 x SX-LEV5H
4 x LEVCURV
1 x DX-LEV5G

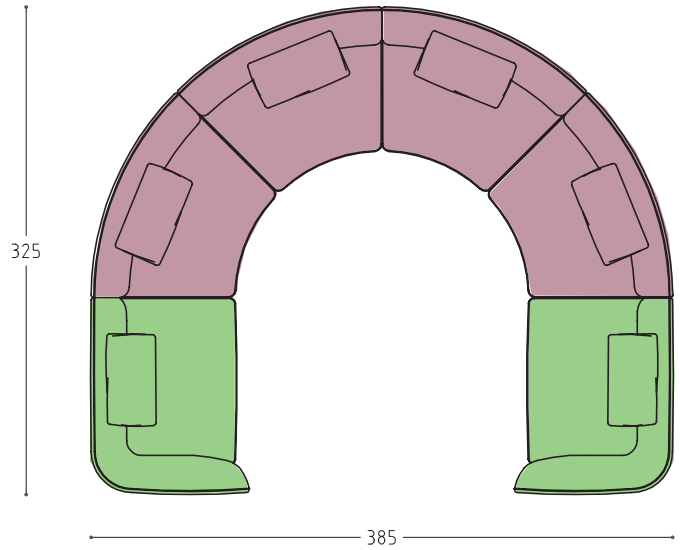

OPTION 17 1 x SX-LEV3F
1 x LEVCONV
1 x DX-LEV3E

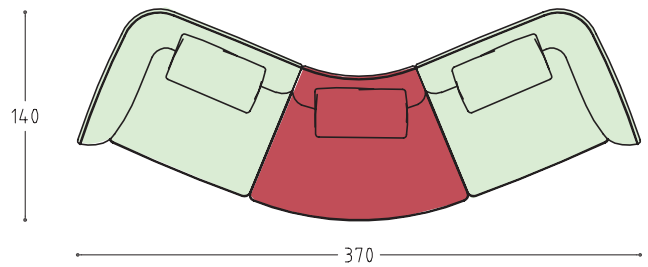

OPTION 18 1 x SX-LEV3F
2 x LEVCONV
1 x DX-LEV3E

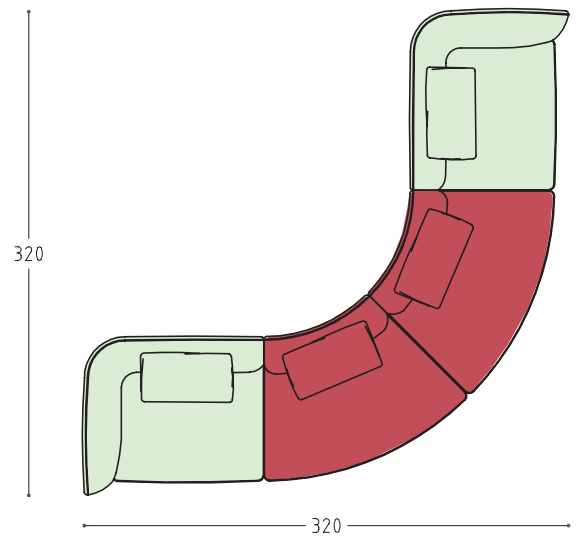

OPTION 19 4 x LEVCONV

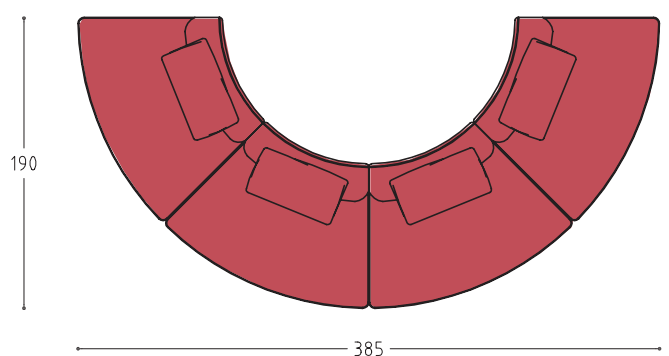

OPTION 20

- 1 x SX-LEV3F
- 1 x LEV20
- 1 x LEVCONV
- 1 x DX-LEV3E

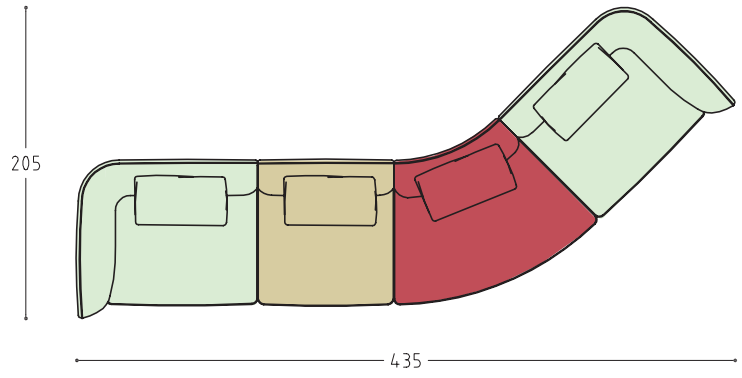

OPTION 21

- 2 x LEVCONV
- 2 x LEVCURV

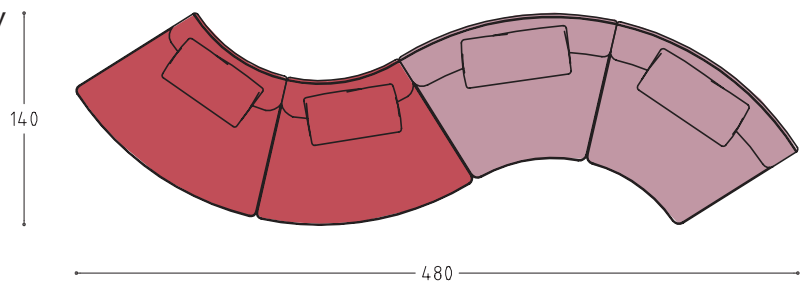

OPTION 22

- 3 x LEVCONV
- 3 x LEVCURV

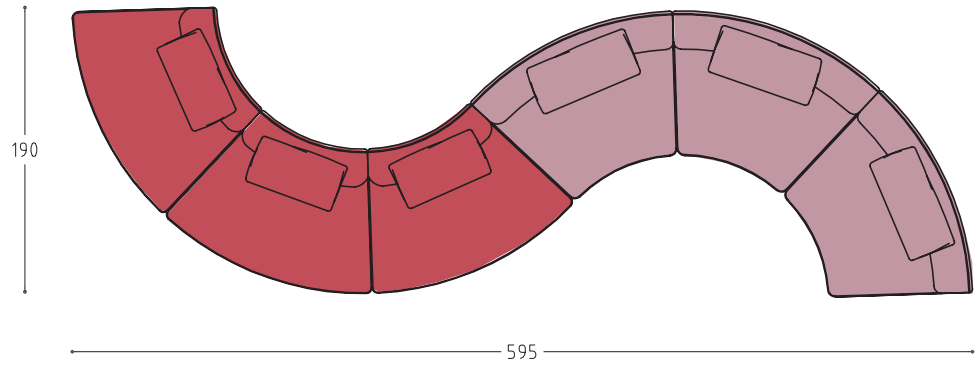

OPTION 23

- 1 x SX-LEV5H
- 2 x LEVCURV
- 1 x LEVCONV
- 1 x DX-LEV5G

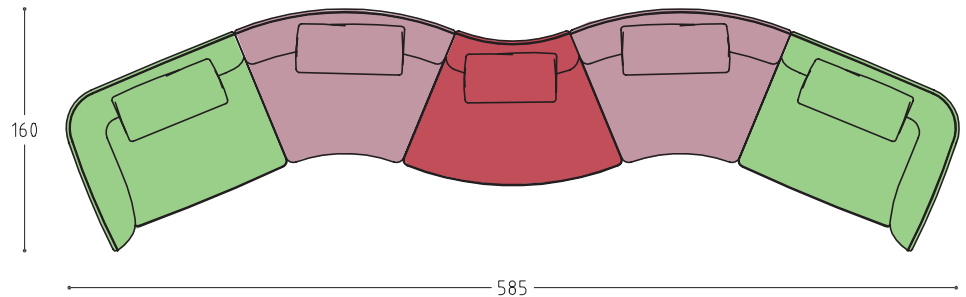

www.blacktiesofas.it